

GEONAV 4 GIPSY



User and Installation Guide

Manuale d'uso e d'installazione

Notice d'emploi et d'installation

Bedienungsanleitung und Installationshinweise

GEONAV 4 GIPSY



User and Installation Guide

INTRODUCTION

The GEONAV is a handheld chartplotter that displays the boat's current position with respect to an electronic chart. The unit is equipped with a built-in GPS receiver that can track up to 12 satellites simultaneously and be interfaced with an external GPS.

The unit can be installed onboard and, at the same time, work as a portable instrument, thanks to rechargeable Li-Ion Polymer batteries. The car navigation functions make the unit a complete car navigator, with turn-by-turn driving functions assisted by voice instructions.

The unit is also equipped with a built-in battery charger that starts operating automatically when the unit is powered. Totally waterproof (IPX7), the unit is equipped with a daylight visible, color TFT display.

Thanks to the GEONAV and a NAVIONICS Platinum™ or Gold™ electronic chart, you will never get lost even in case of fog, bad weather or dark.

The ROUTE function will allow you to plan a trip, MARKERS will allow you to mark points of interest whereas the TRACK function will allow you to record the actual route. Thanks to the unlimited capacity of the new CompactFlash™ cartridges - that can also be used on PCs as personal hard disks - the instrument can store a large amount of route, track and marker data.

NAVIONICS Platinum™ charts provide a detailed coverage of all the most popular boating areas, offer new functions - such as 3D display, satellite photographs, etc. - and can be used in addition to official paper charts to obtain further information such as the availability of port services, as well as tides and

currents data. NAVIONICS Platinum™ or Gold™ electronic charts are available worldwide from authorized NAVIONICS dealers.

NOTE: The technical characteristics and functions described in this manual are subject to change as a result of improvements or changes to the product.

CHARACTERISTICS

General characteristics

- Portable chart plotter with built-in GPS receiver and antenna
- 12-channel internal GPS supporting WAAS/EGNOS
- Satellite acquisition time:
 - 15 seconds (hot start)
 - 2 minutes (cold start)
- GOTO function (Port, Nearest Service, Marker, Lat/Lon)
- Interface for external GPS receiver (optional accessory)
- Chart rotation
- Screen Amplifier™ function
- Autozoom™ function
- Overzoom™ function
- Easy View™ function
- X-Plain™ function
- 8 marker shapes, 8-character name
- Reverse route function
- Selectable depth units (meters, feet and fathoms)
- Platinum™ electronic charts
- Road maps assisted by voice instructions with turn-by-turn driving functions
- 16 zoom levels
- Heading vector
- CompactFlash™ cartridge
- Storage of routes, tracks and markers in separate files on CompactFlash™ cartridges
- Built-in world map
- Waterproof (IPX7)
- Weight: 290 g.

Electrical characteristics

- Input voltage: 5 VDC with external 12/24 VDC power supply protected against reverse polarity and overvoltage
- Battery pack: rechargeable, Li-Ion Polymer batteries (2700 mAh)

- Built-in battery charger
- Power consumption: 4 W
- Operating temperature: -10° to +50° C. Humidity 93%
- Storage temperature: -20°C to +70°C. Humidity 93%
- Color LCD, transfective, TFT 3.5", sunlight visible
- Adjustable display backlight
- Backlit keypad
- Pixel resolution: 240 x 320
- ARM9 RISC processor

Memory characteristics

- Up to 20 waypoints per route
- Up to 500 trackpoints
- Up to 99 markers per group
- Number of routes, tracks and markers: unlimited, depending on the size of the CompactFlash™ utilised

Accessories

- Bracket for fixed installation
- Power supply cable with car lighter plug
- 220 V adapter
- Battery charger speaker
- Headset
- Bracket for bicycle
- Bracket for car installation
- User and Installation Guide

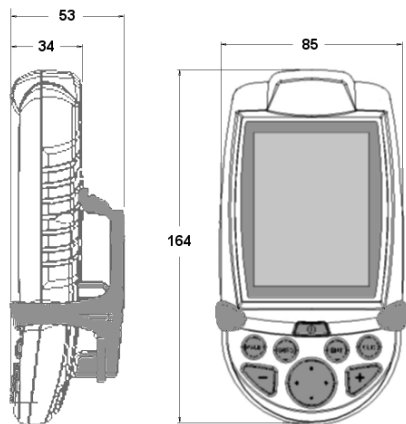

INSTALLATION AND PRECAUTIONS

Precautions

To avoid electromagnetic interference, the GEONAV must be positioned at least 10 centimeters away from magnetic compasses or flux-gate sensors, such as those used on autopilots and remote electronic compasses. The GEONAV is totally waterproof (IPX7) and weatherproof.

It is essential that the slot cover on the unit's rear side is firmly inserted and removed only when the CompactFlash™ needs replacing. Always make sure that, during the replacement operations, the unit is perfectly dry.

NOTE: Any damage caused by the presence of water inside the unit, due to the lack or incorrect installation of the rear cover, is specifically excluded from the warranty.

Cleaning

It is recommended that you use a nonalcoholic product to clean the glass, since alcoholic products may damage the glass surface or make it opaque.

Installation

The GEONAV allows using either the built-in antenna for outdoor installation or an external GPS antenna for indoor use.

NOTE: At start-up, the plotter will select the internal GPS by default.

- **Internal GPS:** For the best reception of satellites, mount your unit in an open area or on the car dashboard to allow the built-in antenna to have the best sky visibility. If the instrument is installed so as to allow full horizon visibility, the best performance will be ensured.
- **External GPS:** In case of poor satellite reception, or use on a car equipped with shielded windscreen, the GEONAV can be connected to the external GPS receiver supplied as an optional accessory.

NOTE: The external GPS receiver works provided that the unit is connected to the external power supply.

Fixed mounting

The plotter can be mounted on any surface using the mounting bracket provided with the unit (see figure).

Use 4 countersunk head screws (4mm) to fix the bracket to the desired mounting surface. Since the bracket does not allow any left or right rotation, make sure that the unit is properly installed for the best view angle.

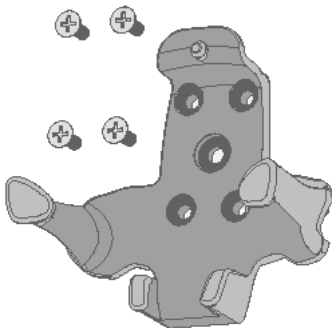

Returning used electrical and electronic devices in EU countries

Users of electrical and electronic devices are obligated to collect used devices separately. Electrical (electronic) used devices may not be disposed of together with unsorted household refuse. The separate collection is a condition for reuse, recycling and utilisation of used electrical (electronic) devices, which ensures the protection of resources. Electrical (electronic) used devices from private household can be returned free of charge. To return your used device, please use the country-specific return and collection systems available to you. Electrical (electronic) devices which are marked with one of the symbols shown may not be disposed of with household refuse in accordance with the EU directive.



CONNECTIONS

Power supply

The GEONAV can be powered by using the appropriate power supply cable with car lighter plug or the built-in battery pack.

Install the power supply cable with the jack connector into the plug 1 as shown in the figure, then exert a light pressure until clicking.

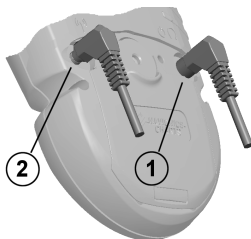

When the cable is disconnected, make sure that the connector is protected by the appropriate rubber cap.

External power supply

The figure below shows the car lighter adapter.



The adapter has a little lamp (LED) that goes on if the car is correctly providing power to the bracket. If the lamp is off:

- check that the 12V voltage is available from the lighter plug;
- open the adapter and check the fuse.

If the fuse is interrupted, replace it with a fuse having the same electrical characteristics (T2A).

NOTE: DO NOT USE ANY BYPASS CIRCUIT.

The fuse ensures that the special protection circuit inside the plotter works properly in case of accidental short-circuit, polarity inversion and overvoltage.

To power the unit through the house electric network (100÷240 VDC), use the appropriate electric network and car lighter adapter, together with the cable with the car lighter plug.

NOTE: The battery charger car lighter adapter or loud-speaker cable shall never be cut in order to connect directly the unit to the external power supply. Any damage caused by the incorrect connection to the external power supply is excluded from the warranty.

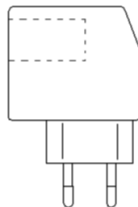

Battery pack

The rechargeable battery pack allows using the GEONAV as a portable unit. The unit can be powered by the batteries only or connected to an external power supply.

When the unit is powered by the power supply cable, the inner batteries are fully recharged, then the inner battery charger is automatically disabled and the batteries disconnected in order to keep their charge.

The full charge cycle of a battery set totally discharged requires at least 6 hours, depending on the battery status, and allows the unit to operate for approximately 8 hours, provided that the backlight switch off is enabled.

NOTE: If, when charging the battery, the unit is turned off, the display will warn the user that the battery charge operation is in progress.

Audio connections

The unit's power supply connector 1 can also be used to connect the earphone or the loudspeaker supplied as an accessory.

Use the car lighter adapter with loudspeaker to listen to the car navigator instructions and, at the same time, to charge the inner batteries, or the earphone to listen to the instructions when the unit functions as a handheld unit.

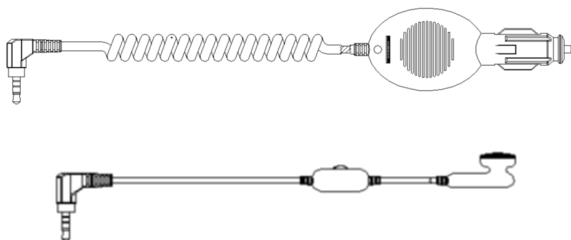

Connection of the external GPS receiver

The connector 2 allows linking the unit to the external GPS receiver supplied as an accessory.

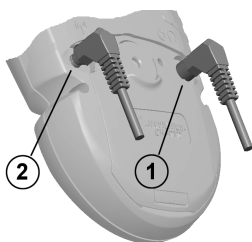

CARTRIDGE INSTALLATION

Installing the CompactFlash™

Make sure that the unit is switched off and perfectly dry. Remove the cartridge slot cover located on the unit's rear side. Insert the cartridge into the appropriate slot, with the label side backwards and push it. Replace the cover and check that it is perfectly closed, in order to avoid any water infiltration.

WARNING: Always use CompactFlash™ cartridges certified by Navionics. The use of non-certified cartridges may result in improper operation of the unit.

The CompactFlash™ cartridges can be used as a mass-storage with any PC computer, so can be the cartridge used by the plotter. However, the plotter needs to find some free space in the cartridge in order to work properly. Prior to use a new cartridge, always make sure that there are at least 2.5MB of free space.

WARNING: Be careful when handling the cartridge files by using the PC. Microsoft Windows allows deleting and moving files easily, therefore avoid erasing the files from the directories present in the cartridge. Damaging the files stored in such directories may result in loss of data or improper operation of the unit.

KEYBOARD

ZOOM+/ZOOM-

Increases/decreases the chart range.

The ZOOM+ key enables the Autozoom function.

It can be enabled whenever an electronic chart is displayed.

ENT (ENTER)

Enters a waypoint or a marker, or confirms a selection from the menu.

PAGE

- Navigation mode:
Turns navigation data pages.
- Cursor mode:
Allows switching from Cursor mode to Navigation mode.

GOTO

Allows plotting a route towards a manual cursor position, desired marker, port, nearest port service or specified position (lat/lon) and accessing the main menu.

CLR

- Navigation mode:
Deletes the current route.
- Cursor mode:
Deletes the last waypoint or the marker pointed by the cursor.

CURSOR

- Moves the manual cursor across the screen.
- Allows switching from Navigation mode to Cursor mode.
- Allows selecting the options from the menu / submenu.

PWR

- Switches the GEONAV on/off.
- Allows adjusting the screen backlight.

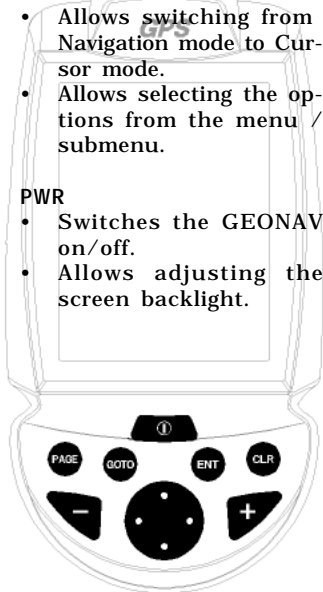

DIAGNOSTIC

The GEONAV features a diagnostic program to verify its correct performance, once installed, and detect problems that may occur during the use of the unit.

To access the diagnostic program, hold the **ENTER** key pressed, while pressing the **PWR** key.

The GEONAV will switch on and carry out automatically a test of the whole system; as soon as the memory test is completed, the program will allow checking the correct operation of the unit's parts.

Press **ENTER** to run one test or **CLR** to skip it and pass to the following test.

WARNING: The unit's internal memory can be cleared by holding the **CLR** key pressed when switching the unit on. This operation will delete all the settings stored in the GEONAV and restore factory settings. Moreover, the routes, tracks and markers not saved on the CompactFlash™ cartridge will be deleted.

NOTE: In case of damaged cartridge or abnormal power spikes, the unit might lock, requiring a power shutdown to restart. In that case, the unit can be turned off without the need of detaching the power or the batteries, but by simply holding the **PWR** key pressed for more than 9 seconds.

MARINE NAVIGATION

READ THIS WARNING BEFORE USING THE GEONAV

WARNING

THE ELECTRONIC CHART IS AN AID TO NAVIGATION DESIGNED TO FACILITATE THE USE OF AUTHORIZED GOVERNMENT CHARTS, NOT TO REPLACE THEM. ONLY OFFICIAL GOVERNMENT CHARTS AND NOTICES TO MARINERS CONTAIN ALL INFORMATION NEEDED FOR THE SAFETY OF NAVIGATION AND, AS ALWAYS, THE CAPTAIN IS RESPONSIBLE FOR THEIR PROPER USE.

The use of the GEONAV implies knowledge and acceptance of this warning by the user.

NAVIONICS ELECTRONIC CHARTS

The GEONAV includes a built-in world map. Additional cartography details relative to a specific area of navigation are available from the CompactFlash™ cartridges storing NAVIONICS Platinum™ or Gold™ electronic charts.

To display chart boundaries, press the GOTO key to display the menu, select SETUP, SET CHART DETAIL and then, by the CURSOR key, select the USER or ALL mode. A small square will locate the area covered by the cartridge installed.

Increasing/decreasing the chart range

Press the -ZOOM+ key. The current chart range is indicated in a small window located in the upper left-hand side of the screen. Chart ranges can go from 4096 NM down to 1/8 NM in Overzoom mode. The range units are shown in the range window.

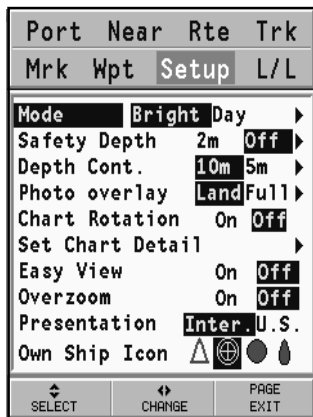

Displaying depth and safety contours, geographical names, spot soundings and light sectors

Press GOTO to display the menu, select SETUP, DEPTH UNITS and enable the option desired (Depth Cont., Safety Cont., Spot Soundings, Names or Light Sectors) by using the CURSOR key.

Converting depth values into the units set

Press GOTO to display the menu, select SETUP, DEPTH UNITS and then set the unit desired to meters, feet or fathoms.

The GEONAV will convert all the depth values in the unit selected,

By querying the lights and nav aids, the X-Plain™ function will give the description of the object in natural language, thus avoiding the use of abbreviations and symbols that are difficult to understand.

By querying the symbols for wrecks or obstructions, NAVIONICS Platinum™ or Gold™ charts will provide the most detailed information available. For example, as far as a boat is concerned, the chart will show its name, the wreck year, the hull length, the depth, etc.

Chart presentation mode

The symbols used to represent the objects on the chart (buoys, lights, landmarks, etc.), as well as chart colors, can be selected between paper-chart International or US styles.

Press GOTO to display the menu, select SETUP, then PRESENTATION (INTER. or US).

Displaying port services

NOTE: This function is available only with the NAVIONICS cartridges containing the Port Services features. If NAVIONICS Gold™ cartridges are used, the supported functions will be those provided by the chart plotters employing only Gold™ charts.

Position the cursor on the  and press ENTER.

A menu will show the options PORTS, PHOTOS, PILOTS and INFO. Select PORTS to display the list of the possible marinas present in the current port: choose the desired marina and press ENTER to display the information available.





Select PHOTOS, choose one item from the list to display one of the photographs available for the marina, then use the ZOOM key to enlarge or reduce the image, and CURSOR to pan it.

Select PILOTS to gain access to the main information on the marina. To display the detailed information available, select the INDEX option from the submenu.

Select INFO to display the list of the services available; a window will show the list of the port services available in the port selected.

Choose the service desired by CURSOR. The number and the type of icon differ from one port to another.

Port services are identified by the following icons:



Info marina



Fuel



Repairs



Customer services



Provisions



Information

Once displayed the list of the services available, those shown in light blue offer further information; select one of them by the CURSOR key and press ENTER to display the additional data available, such as the address, telephone number, business hours, etc. Press ENTER again to carry out a GOTO operation to the service selected.

Displaying Tides and Currents data

NOTE: This function is available only with the NAVIONICS cartridges containing Tides and Currents data.

Position the cursor on the icon of a Tide or Current station, then press ENTER.



If the zoom level is adequate, the present tide or current value will show in the vicinity of the cursor position, together with the curve estimated in the subsequent hours. Press ENTER to display the whole graph.



A graph will show the tide rate or the tidal stream relevant to the station selected, as measured during the current day.

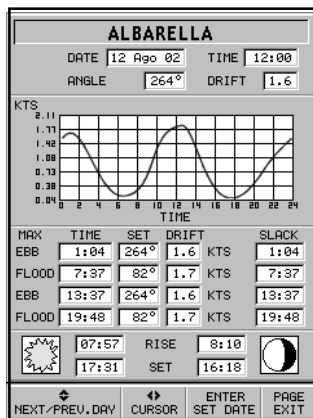
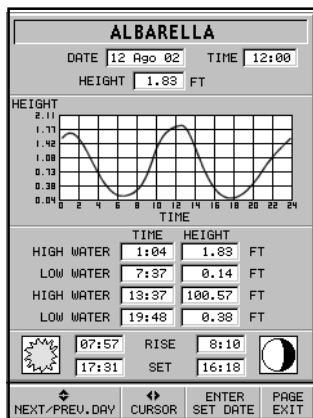

Displaying aerial / satellite charts

NOTE: This function is available only with the NAVIONICS Platinum™ cartridges storing aerial and satellite photographs.

Press **GOTO** to display the menu, select **SETUP**, **PHOTO OVERLAY** and then **LAND** or **FULL**.

From a given zoom level onwards, where available, aerial or satellite photographs will overlay the traditional chart items, only in land areas (**LAND**) or both in land and sea areas (**FULL**).

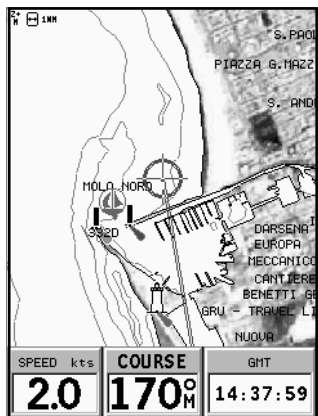

GRAPHIC ITEMS

Besides chart data, the GEONAV displays some graphic items useful during navigation. The figure below shows some of these items.

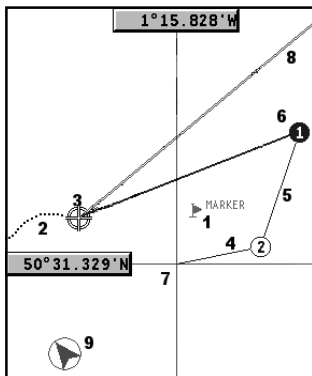
**1 - Marker**

Indicates a point of interest associated with a symbol and a name.

2 - Track segment

Recording of the track actually followed by the boat; the track is displayed as a dashed line.

3 - Boat's position

Boat's position according to the data received from the GPS receiver.

4 - Rubber band

Line joining the last waypoint entered to the manual cursor, or the boat's position to the manual cursor when no waypoint has been entered.

To delete this band, press the PAGE key and switch to Navigation mode.

5 - Route leg

Part of route between two waypoints.

6 - Waypoint

Waypoints are identified by a circle and a number. The route starting point is marked by the "X" symbol. The target waypoint is identified by a filled circle, whereas the route leg currently followed is identified by a thicker line.

7 - Cursor

Indicates the position expressed in geographical coordinates (latitude and longitude).

It is displayed when the plotter is in Cursor mode.

8 - Heading vector

Indicates graphically the boat's current route.

9 - North indicator

Indicates the north direction when the Chart Rotation function is enabled.

FUNCTIONAL CHARACTERISTICS

This chapter describes some of the most important functions of the GEONAV, as well as the terms most commonly used in this document.

Switching on/Switching off the unit

To switch the GEONAV on, keep the PWR key pressed until the unit issues a beep sound to confirm the operation. To switch the GEONAV off, keep the PWR key pressed for more than 1 second.

Selecting marine or land mode

At start-up, the mode enabled is that active when switching the unit off. To switch from marine navigation to road navigation, make sure that the cartridge storing the desired data (marine or land) has been loaded, then select SETUP, NAVIGATION or MARINE NAVIGATOR.

Internal or external GPS antenna

To make the installation easy, the GEONAV can use either its own internal GPS receiver or an external receiver, depending on where the unit is to be installed (indoor or outdoor). To select the internal or external GPS, press GOTO to display the menu, select SETUP, then GPS INT/EXT. Press ENTER to confirm the operation.

Navigation mode (Automatic)

The GEONAV enters the Navigation mode as soon as the internal or external GPS receiver transmits a valid fix. When in Navigation mode, the manual cursor is not displayed. This mode is also called automatic because the unit automatically selects the chart scale and updates the boat's position on the screen.

Cursor mode (Manual)

When in Cursor mode, the manual cursor is displayed. It is possible to edit a route, insert or delete markers, display navaid

information etc. By pressing one of the four arrows in the **CURSOR** key, the unit switches from Navigation to Cursor mode, and the screen is centered in relation to the manual cursor. To return to Navigation mode, press **PAGE**.

Chart rotation

Charts are traditionally displayed in north-up mode. This, however, does not correspond to reality. For example, when traveling southwards, the chart shows, on the right side of the boat, what is actually located on the left side, and vice versa.

The Chart Rotation function allows rotating the electronic chart displayed according to the plotted route (COG - Course Over Ground) as detected by the GPS receiver. Since the COG value varies continuously, a filter has been inserted to prevent the chart from bouncing. To activate the Chart Rotation function, press **GOTO** to display the menu, select **SETUP**, then **CHART ROTATION** and **ON**.

A message will prompt the user to select the requested maximum range before activating the chart rotation.

The northern direction will be indicated by the symbol .

Autozoom

With the Autozoom function the GEONAV will always display automatically the boat's position and the target waypoint at the best available chart range. As the boat approaches the target waypoint, the unit will automatically zoom in. Once the waypoint is passed, the unit will select the best range to

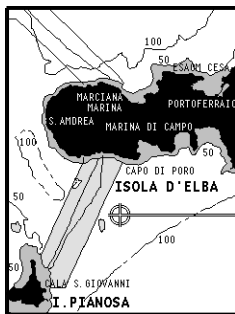

Without rotation

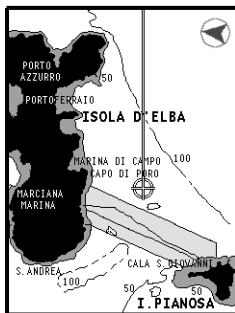

With rotation

display the boat's position and the following waypoint.

To activate the Autozoom function, press ZOOM+ until the "AUTOZOOM ? ENTER = YES" message is displayed, then press ENTER to confirm the operation.

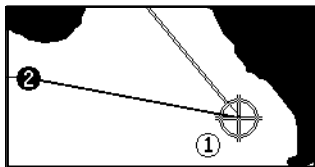

To deactivate the Autozoom function, press the ZOOM key once. When the GEONAV is turned on, and if at least one waypoint has been previously entered, the Autozoom function is automatically activated.

Screen Amplifier

This function automatically redraws the chart according to the boat's course, to maintain 2/3rds of the screen ahead of the boat, provided that the boat's speed is greater than 3 knots. This function will be activated only if no waypoint has been previously inserted.



Without screen amplifier

Overzoom

The Overzoom function allows the chart scale to expand anywhere up to 1/4 NM. The Overzoom does not provide any additional chart detail, but improves only the readability of the existing information, thus acting as a magnifying glass.

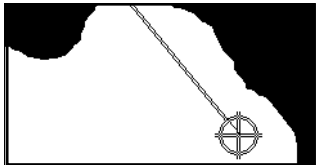

With screen amplifier

When the Overzoom is activated, the unit will warn the user by replacing RANGE with OVZ (blinking) within the navigation window.

To activate or deactivate the Overzoom function, press GOTO to display the menu bar, then select SETUP, OVERZOOM and ON/OFF.

Position calibration

All position sensors have intrinsic errors that make the boat's position incorrect (from few meters to several hundred meters) with respect to the background display of the chart.

This error is caused by the principle at the root of the satellite-derived position system. The position calibration function allows correcting manually the position error present in all GPS devices, provided that this error is not greater than 2 nautical miles.

To carry out the calibration, press GOTO to display the menu bar and then, by the CURSOR key, select SETUP, CALIBRATION and then ON. A message will prompt the user to move the cursor to the boat's true position, appropriately enlarged by the ZOOM+ key.

Press ENTER to move the boat's position to the point indicated by the cursor. This operation will save the calibration for use in future calculations.

NOTE: When the calibration is activated, the coordinates will be marked by (*).

To cancel the calibration, press GOTO to display the menu bar, select SETUP, CALIBRATION and then OFF.

Local time

By this function the user can enter local time instead of the Greenwich time (GMT) supplied by the GPS receiver.

To enter local time, press GOTO to display the menu bar, select SETUP, SET TIME and then LOCAL.

A window will allow entering local time by using the CURSOR key. Press ENTER to confirm the operation.

To cancel local time, press GOTO to display the menu bar, select SETUP, SET TIME and then GMT.

Chart presentation

This function allows the user to select the symbols and colors of chart presentation between International mode and US mode. To change the chart presentation mode, press GOTO to display the menu, select SETUP, PRESENTATION and then choose the option desired.

Display mode

The chart color can be selected among three predefined modes: BRIGHT (bright light), DAY (normal light) and NIGHT (poor light).

Press GOTO to display the menu, select SETUP, MODE and then choose the option desired.

Depth contours

This function allows the user to select the display of depth contours. The options available are:

- 5m: display of contours only with depths up to 5 meters
- 10m: display of contours only with depths up to 10 meters
- 20m: display of contours only with depths up to 20 meters
- ALL: all depth contours are displayed

Safety contours

This function allows the user to display the depth areas corresponding to the safety contour desired. The options available are:

- OFF: no depth area displayed
- Other values: the areas with depths up to the value selected are displayed in shades going from darker blue (for lower depths) to lighter blue (for higher depths). The areas whose depths are over the limit set, and therefore navigable under safety conditions, will be displayed in white.
- Dryline areas are always displayed in green.

NOTE: In NIGHT mode, the areas with depths over the limit set, and therefore navigable under safety conditions, are displayed in black.

Chart loading

At start-up, all the NAVIONICS electronic charts stored in the cartridge are automatically loaded, provided that a CompactFlash™ cartridge has been inserted.

Brightness

Press the PWR key to display the LIGHT window. To adjust the brightness level, press CURSOR. Press PAGE to exit.

Easy View mode

The GEONAV allows doubling the visibility of the electronic chart. Once the Easy View mode has been enabled, the chart will be magnified.

Battery management

When the unit is powered by the batteries, a battery-shaped icon shown in the upper left corner of the screen displays their charge status. The icon shows when the batteries are being recharged, provided that the unit is on.

To increase the life of the battery charge, it is possible to set the automatic switching off of the backlight and screen by selecting SETUP, and then BATTERY SAVING.

If no unit's key is pressed during the time interval set, the backlight and the screen will switch off automatically. As soon as any key is pressed, the unit will automatically switch on again.

Keyboard lock

To lock the keyboard, press the "+" and "-" keys simultaneously. To restore the keyboard operation, press again the "+" and "-" keys.

Anchor alarm

This function allows generating an anchor alarm message that warns the user when the ship moves farther than the

selected distance from its anchoring position, that is the ship's position when the alarm is enabled.

The reference distance value for the alarm can also be set. After the alarm is issued, press any key to reset it by using the current ship's position as the new anchor position. To set this function, press GOTO, select SETUP and then ANCHOR ALARM.

GETTING STARTED

We recommend that you use the GEONAV intuitively, since no damage will be caused by pressing an incorrect button.

Make sure that the unit is powered, insert a CompactFlash™ cartridge and then keep the PWR key pressed until the unit issues a beep sound to confirm the operation.

At start-up, all the NAVIONICS charts stored in the Compact Flash™ will be automatically loaded.

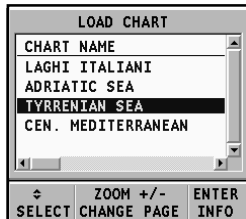

A message will warn the user that electronic nautical charts do not replace official government charts.

Press the PWR key to turn the display backlight on and adjust brightness by the CURSOR key; press PAGE to continue. The Satellite window will show the configuration of the satellites in use. As soon as the GPS receiver has obtained a valid fix (it can take a few minutes), the boat's position and the relevant area will be displayed at the best scale available.

The default language is English. To change the language, press GOTO to display the menu, then select SETUP, LANGUAGE and the desired language by the CURSOR key.

The line, or vector, starting from the boat indicates the boat's direction, to be ignored if the boat is stationary.

The window situated in the lower part of the screen will display the boat's speed, route and chart scale.

The GEONAV is in Navigation mode; by pressing the CURSOR key, it is possible to switch to Cursor mode (editing mode). The cursor geographical position is shown by two windows.

To plot a route starting from the boat's position, move the cursor to the position desired, and press ENTER to insert a waypoint at the cursor's position. A circle containing the number 1 will show. The info windows show the distance, bearing, time to reach the target waypoint and time of arrival.

Press the PAGE key to go back to Navigation mode. To add more waypoints, press CURSOR and repeat the operations described above.

As new waypoints are added, the numbering will increase progressively. In case of error, waypoints can be deleted by pressing the CLR key (Cursor mode), starting from the last entered. To go back to Navigation mode, press PAGE.

NOTE: The cursor can be moved to the desired position by using the GOTO function as well. See the relevant sections for more details.

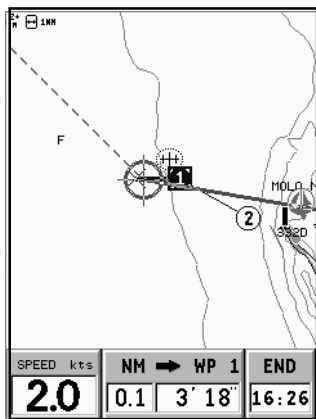
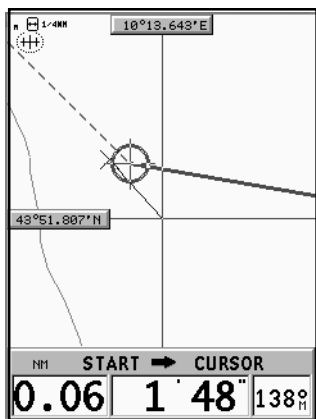

OPERATING MODES

The GEONAV can operate in two different modes, Cursor and Navigation, each giving access to different functions.

CURSOR MODE

When the GEONAV is in Cursor mode, the crosshair cursor is displayed. The CURSOR key allow browsing through the electronic chart, as well as editing or creating the route. See the *Route* Section for more details. To enter the Cursor mode, press the CURSOR key.

NAVIGATION MODE

In Navigation mode, the boat's position icon replaces the crosshair cursor and several data windows can be accessed. To enter the Navigation mode, press the PAGE key repeatedly. As the fix is valid, the windows sequence is the following:

NAVIGATION > TRIP > SATELLITE > INFO > TIDE INFO > RUNWAY > 3D

The Tide Info window is displayed provided that a NAVIONICS cartridge featuring Tides and Currents data is active (see the *Tide Info Window* Section).

RANGE WINDOW

This window, always present, shows the following information:

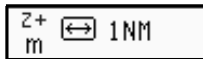

- Zoom status (top left corner):
 - Z+ means the chart can be further enlarged by pressing ZOOM+;
 - no indication means the chart is shown at the best possible level;
 - OVZ means the chart is shown in Overzoom mode, i.e., it is overzoomed without adding any further graphic detail.
- Chart range (right hand side), ranging between 4096 NM and 1/8 NM. The icon aside means that the range matches the overall screen width.
- Units of measurement for depth and heights (left hand side):
 - meters (m)
 - feet (ft)
 - fathoms (fa)

To change the units, press the GOTO key, then select SETUP, DEPTH UNITS and choose the units desired.

NAVIGATION WINDOW

This window is activated automatically as soon as the GPS receiver has obtained the boat's position (FIX OK).

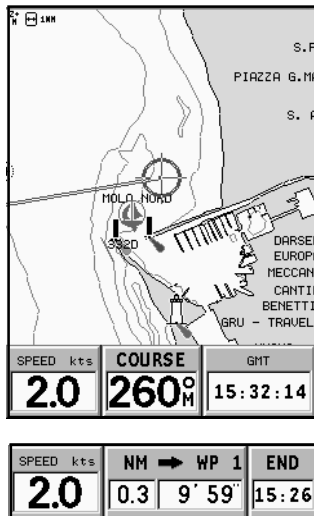

If no route is present, speed, course and chart range are displayed at the bottom of the screen.

By using the ZOOM key, the chart range can be changed, thus accessing NAVIONICS chart data.

If a route has been inserted, the screen will display the following data:

- Boat's speed
- Distance from the target waypoint
- Estimated time of arrival at the target waypoint

TRIP WINDOW

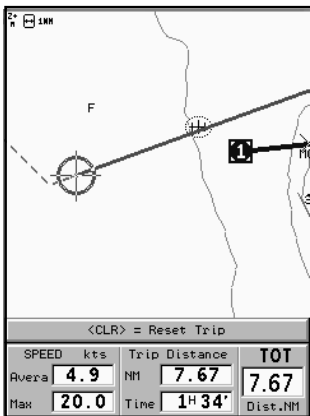

The trip window shows the data relating to the route followed and, in particular:

- Average speed
- Time elapsed from departure
- Partial distance covered
- Total distance covered

To reset partial counters before starting a new journey, press CLR.

SATELLITE WINDOW

At start-up the satellite window displays how many and which satellites are tracked by the GPS receiver.

The outer circle represents the horizon, the inner one identifies a 45° elevation with respect to the horizon, and the central circle points to the zenith. The small squares with numbers show the satellites available. The numbers of differential satellites, if any, are displayed from bottom to top.

As soon as the satellite is tracked by the GPS receiver, the square turns red. The bars displayed on the left identify the signal quality; the longer the bar, the higher the signal quality.

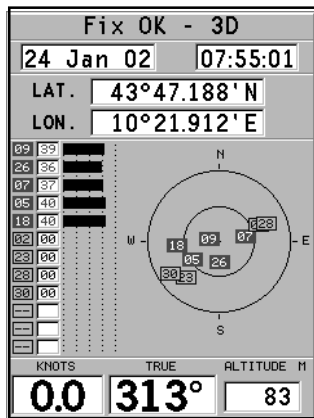

On the left of each bar, two digits indicate numerically the signal/noise ratio.

Additional information:

- Day, month, year, local or Greenwich time (at the first start-up the GEONAV is initialized to Greenwich Time).
- Boat's position (lat/lon) (or the latest valid fix if the GPS receiver is still searching for satellites).
- Data on the current satellite situation (number and fix).
- SOG, COG and altitude.

The latitude and longitude values relevant to the boat's posi-

tion are displayed as soon as three satellites are tracked and a 2D fix (two dimensions) is available.

The altitude value is available only if four satellites are tracked and a 3D fix is obtained.

As soon as a valid fix is available, the GEONAV will automatically switch to Navigation mode and display the boat's position at the best chart range available; the window at the bottom of the screen will indicate the boat's course and speed.

To recall the Satellite window, press the PAGE key repeatedly until it appears.

INFO WINDOW

This window displays the following information on the boat's current position:

- Geographical coordinates (latitude/longitude)
- The position correction applied to the latitude and longitude (option SETUP, CALIBRATION)
- Magnetic variation value received by the GPS
- Course (COG)
- Speed (SOG)

NOTE: This window is available in Navigation mode only.

SHIP POSITION		
LATITUDE		
45° 15.000N*		
LONGITUDE		
179° 50.000W*		
CALIBRATION		
dLAT	dLONG	
1° 15.000N	2° 15.000W	
COG	SOG	KM/H
145° M	51.0	
MAG. VAR.	15.0 W	

TIDE INFO WINDOW

When a NAVIONICS cartridge featuring Tides and Currents data is present, this window displays further information, besides the forecast data supplied by selecting the Tides and Currents station.

The following data is displayed:

- Latitude and longitude at the current boat's position
- Current time and date
- Value of magnetic variation received by the GPS
- Dawn and sunset time
- Moonrise and moonset time
- Moon phase
- Graph of estimated tide level with respect to the current position

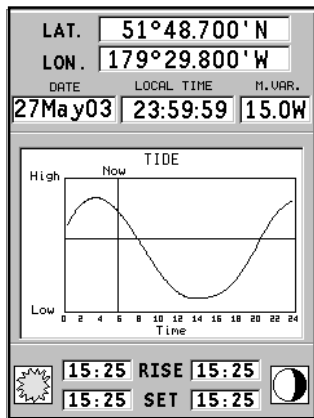

WARNING: Unlike the graph displayed at a T&C station position (accessible through the GOTO function, or by positioning the cursor on the Tides and Currents station symbol) which is as accurate as supplied by hydrographic offices, this graph shows estimated data, being the result of interpolation between the two Tides and Currents stations nearest to the point of interest. The accuracy of the estimate may vary, depending on the coast type, the distance to the nearest stations, and other geographical features.

RUNWAY WINDOW

This window displays the following information on the target waypoint:

- Name of the target waypoint
- Distance from the target waypoint
- Estimated time of arrival to the target waypoint
- Bearing
- Course
- Steering angle
- XTD (right/left distance from the planned route)

The graph shows the boat's position with respect to the route. When the XTD goes up to the limit of 2 NM, the boat symbol will reach the right or left side of the runway.

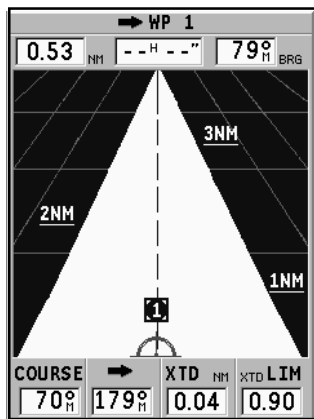

NOTE: This window is available in Navigation mode only.

3D WINDOW

NOTE: This function is available only with the NAVIONICS Platinum™ cartridges.

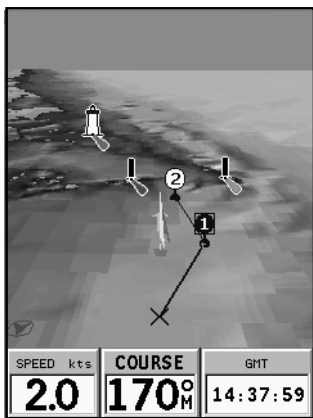

This window allows displaying a 3D chart image of the area surrounding the current boat's position.

Press the PAGE key repeatedly to display the 3D navigation window, then use the CURSOR key to move the viewing angle and the ZOOM key to enlarge or reduce the image.

The ENTER key allows to raise the view point and rotate the view. Press ENTER once or twice to switch from one function to another.

To choose the level of detail of the items to display, as well as the quality of the picture, press GOTO to display the menu, select SETUP, then 3D WINDOW and edit the options as desired.

MAIN MENU

The menu bar, displayed at the top of the screen, allows selecting from the following options:

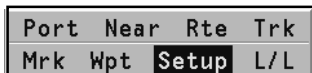

TRACK: To activate/deactivate the track function and to save, recall and delete the track saved.

ROUTE: To delete, reverse, store, recall a route and display route information.

MARK: To delete, store and recall markers.

SETUP: To activate/deactivate the unit's setup.

GOTO PORT: To plan a route to a selected port.

GOTO NEAREST: To plan a route to the nearest port service.

GOTO LAT/LON: To plan a route to a known geographical position.

GOTO WPT: To plan a route to a specific waypoint (function available in Navigation mode only).

INFO: To display the information relative to the waypoint pointed to by the manual cursor (function available in Cursor mode only).

NOTE: The majority of menu items, once selected, show a series of submenus. Use the **CURSOR** key to move from one menu to another and press **ENTER** to choose one of the items.

ROUTE

EDITING A ROUTE (CURSOR MODE)

Creating a waypoint

Using the CURSOR key, move the cursor on the position desired and press ENTER to insert a waypoint.

To enter further waypoints, move the cursor and press ENTER. The new waypoint will be appended to the existing route.

Up to 20 waypoints per route can be entered by using the GOTO function as well (see the *Route to a waypoint* Section).

Deleting the last waypoint

Press CLR. If the last waypoint is out of screen, the “DELETE WP? ENTER = YES” message will be displayed.

Press ENTER to confirm the deletion.

Deleting a waypoint

Use the CURSOR key to position the cursor on the waypoint to delete and press CLR.

Deleting all waypoints in a route

Press the CLR key repeatedly until the “NO WP PRESENT” message is displayed.

Moving a waypoint

Position the cursor exactly on the waypoint to be moved; press ENTER to capture the waypoint, then move the waypoint to the position desired and confirm the operation by pressing ENTER.

Inserting a new waypoint in a route

Position the cursor exactly on the route leg to edit and press ENTER to capture the leg.

Once captured, the leg will show a thicker line to distinguish it more easily from the other route legs. A window will also show the leg captured. Move the manual cursor to the position desired, insert the new waypoint and confirm by pressing ENTER.

EDITING A ROUTE (NAVIGATION MODE)

If the manual cursor is displayed, press the PAGE key to enter Navigation mode.

Changing the target waypoint

Use the “Route to a waypoint” function.

WARNING: The route will be modified and the new target waypoint selected will be the first waypoint in the route.

Deleting all waypoints

Press the CLR key to show the “DELETE ROUTE? ENTER = YES” message. Press the ENTER key to confirm the deletion or another key to exit.

FUNCTIONS IN THE ROUTE MENU**Route info**

Route information is displayed in two pages; the first shows general route information, whereas the second contains the geographical coordinates of all waypoints. Press the GOTO key to display the menu bar, select ROUTE, CURRENT, GOTO WP and then confirm by ENTER.

A window will show the following information:

WP NO.: Waypoint ID

DISTANCE: Distance from START to current waypoint

TIME: Estimated time from START to current waypoint

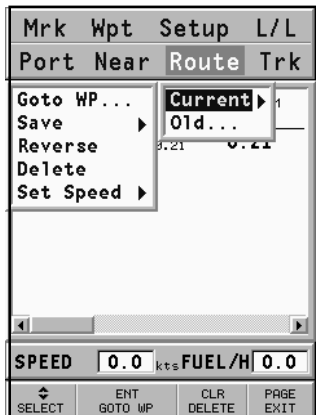

FUEL: Estimated fuel consumption (liters)

BRG: Bearing from previous waypoint to current waypoint

The arrival time at the waypoint and the fuel consumption will be displayed provided that estimated speed and fuel consumption values have been inserted previously (see the *Entering speed and fuel consumption data* Section).

Use the **CURSOR** key to switch to the next page showing the geographical coordinates of each waypoint:

WP NO.: Waypoint ID

POSITION: Waypoint latitude and longitude

Use the **CURSOR** key to go back to the previous page or press the **PAGE** key to exit.

To access the waypoint data, move the manual cursor on the waypoint of interest, press the **GOTO** key and select the **INFO** option.

Entering speed and fuel consumption data

The data are used to calculate the values displayed in the **ROUTE** window.

Press the **GOTO** key to display the menu, select **ROUTE**, **CURRENT**, **SET SPEED** and press **ENTER** to access the windows for data insertion. Use **CURSOR** to enter the data required and to confirm the operation.

Storing a route in the CompactFlash™

Press the **GOTO** key to display the menu, select **ROUTE**, **CURRENT**, **SAVE** and press **ENTER**. Use the **CURSOR** key to change the default name and press **ENTER** to confirm the operation.

A message will confirm that the route has been stored correctly. Once stored, the route will disappear from the screen.

Recalling a route from the CompactFlash™

Press the GOTO key to display the menu, select ROUTE, OLD and press ENTER to open the route catalog; select the route by the CURSOR key and then press ENTER to confirm, or PAGE to exit.

The route recalled will be displayed, the Autozoom function automatically enabled and a window will allow selecting the target waypoint.

Deleting a route

To delete the route displayed, press the GOTO key to show the menu, select ROUTE, CURRENT, DELETE and press ENTER to confirm.

To delete a route stored in the CompactFlash™, press the GOTO key to show the menu, then select ROUTE, OLD.

Select the route from the list of the routes stored in the CompactFlash™, then press CLR to delete it and ENTER to confirm the operation.

Reversing a route

Press the GOTO key to display the menu, then select ROUTE, CURRENT, REVERSE. The waypoint order will be automatically reversed allowing navigation in the opposite direction.

Route to a waypoint

Press the GOTO key, select ROUTE, CURRENT, GOTO WP and move the cursor within the waypoint list by using the CURSOR key. Press ENTER and select the target waypoint by CURSOR. Press ENTER to confirm the selection, or PAGE to exit.

As the GEONAV plots a new route, the waypoint selected becomes the first waypoint in the route, whereas previous waypoints are deleted. This function is available in Navigation mode only.

This function can be accessed also by selecting the WPT item from the GOTO main menu.

TRACK

The Track function allows recording the track actually followed by the boat. The Track function can be enabled and disabled several times during navigation.

Starting a track

To enable the Track function, press the GOTO key to display the menu bar, select TRACK, START and press ENTER to confirm. A small circle on the boat's position will indicate the track starting point.

Stopping a track

To disable the Track function, press the GOTO key to display the menu bar, select TRACK, STOP and press ENTER to confirm.

Storing a track in the CompactFlash™

Press the GOTO key to display the menu bar, select TRACK, CURRENT, SAVE ALL and press ENTER to confirm. Use the CURSOR key to change the default file name and press ENTER to confirm the operation.

A message will confirm that the track has been stored correctly. Once stored, the track will disappear from the screen.

Each time a track is stored in the CompactFlash™, the plotter's memory is cleared and the indicator of memory used in the TRACK menu is reset to 0%.

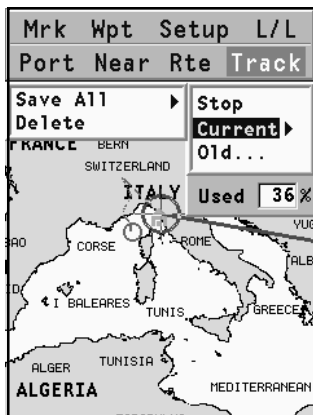

Recalling a track from the CompactFlash™

Press the GOTO key to display the menu bar, select TRACK, OLD and press ENTER to open the track catalog.

Select the track desired, then press ENTER to confirm the operation or PAGE to exit.

Deleting a track

To delete the track displayed, press the GOTO key to show the main menu, select TRACK, CURRENT, DELETE and press ENTER to confirm.

To delete a track stored in the CompactFlash™, press the GOTO key to show the menu, then select TRACK and OLD. Select the track from the list of the tracks stored in the CompactFlash™, then press CLR to delete it and ENTER to confirm the operation.

MARKER

Markers are used to identify points of interest to which names and symbols can be assigned.

NOTE: Marker names are displayed starting from the 32 NM chart range.

CURSOR MODE

Inserting a marker

Move the cursor to the position desired and hold the ENTER key pressed for more than 2 seconds. A window will display the symbol and a name automatically assigned to the marker.



Use the CURSOR key to change the marker symbol (8 symbols available) and name (max. 8 characters) according to the type of marker to store (e.g., fishing spots, wrecks, rocks, etc.). Press ENTER to confirm the insertion.

NOTE: The cursor can be moved to the desired position also by using most of the GOTO functions. See the relevant sections for further details.

Changing a marker name/symbol

Position the cursor on the marker desired and press ENTER; a window will display the symbol and the name previously assigned to the marker selected. Use the CURSOR key to change the marker name and symbol. Press ENTER to confirm the operation.

Deleting a marker

Position the cursor on the marker to delete and press CLR.

NAVIGATION MODE

Inserting a marker

Press the ENTER key to insert a marker at the boat's position. A window will display the symbol and the name automatically assigned to the marker; to change the marker symbol and name

according to the type of marker to store (e.g., fishing spots, submerged wrecks, rocks, etc.), use the **CURSOR** key. Press **ENTER** to confirm the insertion.

Route to a marker

Press the **GOTO** key and select **MARKER**, **CURRENT**, **GOTO MARKER** by the **CURSOR** key. The catalog displayed will list, with respect to each marker, the symbol, the name, the insertion date and time.

Moreover, the catalog shows the number of markers entered in the current page and the number of markers still available. By using **CURSOR**, choose the desired marker (the latest 8 markers used will be highlighted) from the catalog displayed, then press **ENTER** to confirm.



Once the desired marker has been selected, the GEONAV will insert a waypoint at the marker position and append the new leg to the existing route (if no route is available, the new waypoint will be connected to the boat's position). Press the **PAGE** key to go back to Navigation mode and enable automatically the Autozoom function.

NOTE: To delete a single marker, select it from the **GOTO Marker** list and press the **CLR** key.

FUNCTIONS IN THE MARKER MENU

Storing a set of markers in the CompactFlash™

Press the **GOTO** key to display the menu, select **MARKER**, **CUR-**

RENT, SAVE ALL and press ENTER to confirm. Use the CURSOR key to change the default name and press ENTER to confirm.

A message will confirm that markers have been stored correctly. Once stored, markers will disappear from the screen.

Each time a set of markers is stored in the CompactFlash™, the plotter memory is cleared and the indicator of the markers available is reset to the maximum value.

Recalling a set of markers from the CompactFlash™

Press the GOTO key to display the menu, select MARKER, OLD and press ENTER to open the marker catalog.

Use the CURSOR key to select the set of markers desired and press ENTER to confirm, or PAGE to exit.

Deleting markers

To delete the set of markers displayed, press the GOTO key to show the menu, select MARKER, CURRENT, DELETE ALL and press ENTER to confirm.

To delete a single marker among those displayed, press the GOTO key to show the menu, select MARKER, CURRENT and GOTO MARKER. Select the marker desired from the list shown, then press CLR to delete it and ENTER to confirm the operation. To delete a set of markers stored in the CompactFlash™, press the GOTO key to show the menu, then select MARKER and OLD. By using the CURSOR key, select the set of markers from the list of those stored in the CompactFlash™, then press CLR to delete it and ENTER to confirm the operation.



GOTO PORT

Press the GOTO key and select PORT by CURSOR.

The list will display the latest ten ports previously selected. Choose the desired port by CURSOR, or select New to display the whole list of the ports stored in the cartridge.

By moving the CURSOR key in the four directions, form the port name, or part of it; when the desired port is shown, highlight it by CURSOR and confirm its selection by pressing ENTER.

Once the desired port has been selected, the GEONAV will insert a waypoint in the port position and append the new leg to the existing route (if no route is available, the new waypoint will be connected to the boat's position).

Press the PAGE key to go back to Navigation mode and enable automatically the Autozoom function.



GOTO NEAREST

NOTE: This option is available only with the NAVIONICS cartridges containing the Port Services features. It allows finding and heading for the nearest port featuring the service desired. The NAVIONICS Platinum™ cartridges offer a wide choice of services, whereas, when using NAVIONICS Gold™ cartridges, the functions supported will be those provided by plotters employing Gold™ charts only.

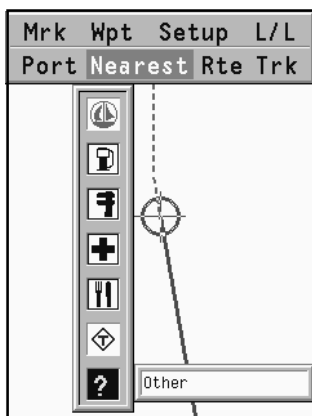

Press the GOTO key, select NEAR by the CURSOR key, choose the desired service and press ENTER to confirm, or CLR to cancel the operation.

The GEONAV will show the three destinations closest to the boat's position (if in Navigation mode), or to the cursor's position (if in Cursor mode), and position automatically on the closest destination (flashing).

Select one port at a time by using CURSOR; a window will show the distance and time to arrive (estimated on the boat's current speed). Press ENTER to confirm the selection.

The GEONAV will insert a waypoint in the port selected, delete automatically the existing route (if in Navigation mode), or append the waypoint to the existing route (if in Cursor mode), then go back to Navigation mode and enable automatically the Autozoom function.

Besides the specific set of services shown in the figure, a generic set is available. It gathers several additional services (such as hotels, restaurants, airports, shops, etc.) that can be searched for and located thanks to this function.

Tide or current forecast at the nearest survey station

NOTE: This function is available only with the NAVIONICS cartridges containing Tides and Currents data.

This function allows displaying, within the space of twenty-four hours with respect to the selected date, the tide level and tidal current speed and direction at a survey station in the vicinity. Unlike the estimated data shown in the Tide Info window, this forecast is much more accurate, being supplied directly by tidal surveying stations.

Press **GOTO**, select **NEAREST** by the **CURSOR** key, choose the Tides or Currents service, then press **ENTER** to confirm. The **GEONAV** will allow selecting one of the three nearest Tides and Currents stations. Use the **CURSOR** key to choose the station desired and press **ENTER** to confirm.

A window will show the information reported below:

Tide station

- Name of the station
- Forecast reference date
- Time and height with respect to the cursor's position in the graph
- Time and height of high/low water
- Dawn and sunset time
- Moonrise and moonset time
- Moon phase
- Tide level graph (24 hours)

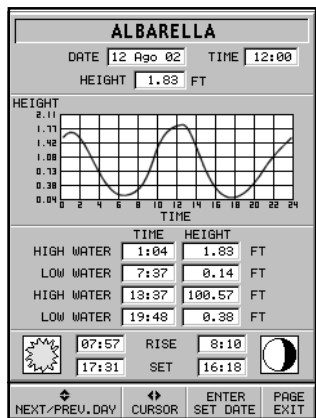

Tidal current station

- Name of the station
- Forecast reference date

- Time, speed and direction with respect to the cursor's position in the graph
- Time, speed, direction and slack time of daily flood and ebb streams
- Dawn and sunset time
- Moonrise and moonset time
- Moon phase
- Tide level graph (24 hours)

In both cases above, the default date is today. A different date can be set by pressing **ENTER**.

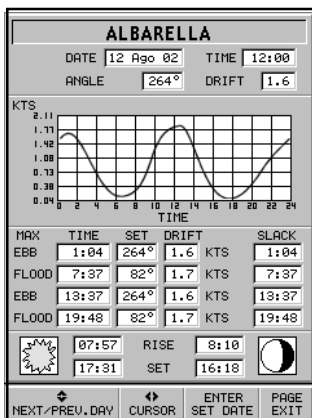

NOTE: The same information can be accessed by positioning the manual cursor on the icon of a Tides or Currents station, and pressing **ENTER** to confirm.

SETUP

The Setup menu allows setting the available options.

To access the Setup menu, press GOTO to display the main menu, then select SETUP by using the CURSOR key. The menu items are grouped in six sets. When selecting a set by the CURSOR key, the list of the available options will be displayed. Press ENTER to select one set, then use the CURSOR key to switch from one option to another and edit the setting.

To go back to the set list, press PAGE.

DISPLAY

- **Mode (BRIGHT/DAY/NIGHT)**
Selects the colors suitable for the brightness of the environment.
- **Safety Depth (OFF/2m/5m/10m/20m)**
Enables the display of the areas corresponding to the depth safety limit.
- **Depth Contours (ALL/5m/10m/20m)**
Selects the display of depth contours.
- **Photo Overlay (LAND/FULL/OFF)**



- **Photo Overlay (LAND/FULL/OFF)**
Selects the enabling of the overlay of satellite photographs for charts: only on land, everywhere or off, respectively.
- **Chart Rotation (ON/OFF)**
Enables/disables the Chart Rotation function.
- **Set Chart Detail (STD/USER/ALL)**
Selects the chart details to display. It is possible to select one of the two settings available (STD - equivalent to the standard display setting, as defined by ECS regulations - and ALL, that enables the display of all the items on the chart).

By choosing USER, enables/disables the display of the single items.

- Easy View (ON/OFF)
Enables/disable the Chart Magnification function.
- Overzoom (ON/OFF)
Enables/disable the Overzoom function.
- Presentation (INTER./U.S.)
Selects the symbols and colors of chart presentation.
- Own Ship Icon
Selects the icon that will identify the ship's position on the screen.

3D DISPLAY

- Names (ON/OFF)
Enables/disables the visualisation of names in the 3D display.
- Nav aids (ON/OFF)
Enables/disables the visualisation of nav aids in the 3D display.
- Photo (ON/OFF)
Selects the type of texture for the 3D display, to choose from satellite photograph and simple texture.

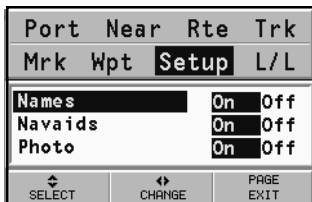

NAVIGATION

- Calibration (ON/OFF)
Calibrates the ship's position received by the GPS device.
- Anchor Alarm (OFF/15m/30m/50m)
Enables/disables the alarm and sets the distance range for the anchor alarm.

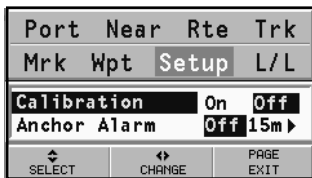

UNITS AND LANGUAGE

- **Set Time (LOCAL/GMT)**
Enters local time.
- **Distance Units (NAUT/METR/STAT)**
Selects distance units.
- **Depth Units (M/FT/FA)**
Selects depth units.
- **Bearing (TRUE/MAG)**
Sets the magnetic mode for all bearings.
- **Language (EN/FR/ES/DE/DK/IT/SV/NL/SU/NO/GR)**
Selects the language.

Port	Near	Rte	Trk
Mrk	Wpt	Setup	L/L
Set Time	Local	GMT	
Dist. Units (NM,kts,ft)...			
Depth Units	m	ft	fa
Bearing	True	Mag	
Language	En	Fr	EsDeIt ▶
SELECT	CHANGE	PAGE EXIT	

WINDOWS

- **Selects the auxiliary windows to display.** For every window, a preview image - whose display can be enabled/disabled (ON/OFF) - is available.

Port	Near	Rte	Trk
Mrk	Wpt	Setup	L/L
Satellite	On	Off	
General Info	On	Off	
Tide Info	On	Off	
Runway	On	Off	
Trip Window	On	Off	
3D Window	On	Off	
SELECT	CHANGE	PAGE EXIT	

OTHER

- **GPS (INT/EXT/DIFF)**
Selects the built-in GPS, an external GPS antenna or the built-in GPS with the reception of WAAS/EGNOS differential satellites (if available).
- **Battery Saving (ON/OFF)**
Sets the automatic switching off time for the backlight and screen, in order to reduce the battery consumption.

Port	Near	Rte	Trk
Mrk	Wpt	Setup	L/L
GPS	Int	Ext	▶
Battery Saving	On	Off	
Chart Info			▶
SELECT	CHANGE	PAGE EXIT	

- **Chart Info**

By selecting ON, a window will show the catalog of the charts stored in the cartridge. Select one chart by the CURSOR key and press ENTER to display the information associated with the chart (chart number, authority that issued it and date of issue), or PAGE to exit.

GOTO LAT/LON

Press the **GOTO** key and select **L/L** by the **CURSOR** key. Enter the geographical coordinates desired by using **CURSOR** and confirm the insertion.

The **GEONAV** will move the manual cursor to the position selected, allowing the insertion of a waypoint or a marker.

ROAD NAVIGATION

READ THIS WARNING BEFORE USING THE GEONAV

WARNING

THE CAR NAVIGATOR SHOULD BE INSTALLED SO AS NOT TO INTERFERE WITH THE VEHICLE CONTROLS AND/OR SAFETY FEATURES, AND NOT TO OBSTRUCT THE DRIVER'S VIEW. IT SHOULD NOT BE USED BY THE DRIVER, NOR DISTRACT THE DRIVER'S ATTENTION WHEN THE VEHICLE IS IN MOTION.

IT IS RECOMMENDED TO PAY ATTENTION TO ROAD SIGNS: THE INSTRUCTIONS PROVIDED BY THE CAR NAVIGATOR SHOULD BE CONSIDERED AS SUGGESTIONS, NOT AS DRIVING INDICATIONS WHICH COULD RESULT INCORRECT DUE TO INACCURATE MAP DATA OR CHANGES TO ROAD PRACTICABILITY.

The use of the GEONAV implies knowledge and acceptance, by the user, of this warning and the warnings reported in the manual.

NOTE: This function is available only when using NAVIONICS land cartography cartridges.





ROAD MAPS





During navigation, the unit displays the map of the area surrounding the vehicle, highlighting the way to follow in order to reach the destination set. The map also shows the surrounding roads, as well as all the point of interest available in the area.

The position of the vehicle is indicated by the symbol  showing the vehicle's heading, whereas the direction to follow is highlighted by an arrow overlapping the road suggested.

The points of interest, that indicate the availability of services such as restaurants, hotels, filling stations, etc., are represented on the road map by the relevant icons. The list of the icons available is reported below.

	Airport entrance
	Airport
	Children's playground
	Beach
	Café/Pub
	Camp site
	Garage
	Autom. teller machine
	Casino

	Church
	Cinema
	Town center
	Town hall
	University
	Meeting center
	Cultural center
	Dentist
	Doctor

	Embassy		Place of worship
	Entertainment		Police
	Ferry boats		Post office
	Ferry boat terminal		Railway station
	Golf		Car rental
	Government office		Car rental parking lot
	Hospital/General hospital		Rest area
	Hotel/Motel		Restaurant
	Major tourist attraction		Restaurant area
	Institute		Panoramic viewpoint
	Library		Shop
	Monument		Shopping mall
	Museum		Sports center
	Music center		Stadium
	Nightclub		Swimming pool
	Unguarded parking lot		Theater
	Park/Garden		Tourist information
	Garage parking lot		Veterinarian
	Filling station		Marina
	Pharmacy		Zoo

FUNCTIONAL CHARACTERISTICS

This chapter describes some of the most important functions of the GEONAV, as well as the terms most commonly used in this document.

Switching on/Switching off the unit

To switch the GEONAV on, keep the PWR key pressed until the unit issues a beep sound to confirm the operation. To switch the GEONAV off, keep the PWR key pressed for more than 1 second.

Selecting the marine or land mode

At start-up, the mode enabled is that active when switching the unit off. To switch from marine navigation to road navigation, make sure that the cartridge storing the desired data (marine or land) has been loaded, then select SETUP, NAVIGATION or MARINE NAVIGATOR.

NOTE: If the cartridge currently inserted contains no road maps, as soon as the CAR NAVIGATION option is selected, the unit will automatically turn off after showing a warning message. At the following power on, the unit will start in marine navigation mode.

Voice instructions

As mentioned in the introductory chapter, in compliance with the safety regulations, the car navigator helps the user to follow the itinerary defined thanks to voice instructions. The power cord includes a speaker with adjustable volume and a jack for the external GPS powered by this cord.

The instructions and information provided by the speaker concern:

- Entrance/exit ramps of highways, bridges, forks, traffic circles and services.
- Automatic recalculation of the route in case of diversion from the planned route.

- Confirmation of arrival at destination.

To repeat the message concerning the following manoeuvre, press the ENTER key. Voice messages are enabled also in Simulation mode.

GETTING STARTED

At start-up, the unit displays a welcome message and warning. The warning message reminds the user that the instructions provided by the car navigator should be considered as suggestions, and not as real indications, which could not take, for example, changes to road practicability into account.

Press the **PAGE** key to display the start-up screen, then use the **PAGE** key to scroll the windows available (navigation, trip, satellite and route info), if enabled from the Setup menu.

NAVIGATION WINDOW

The navigation window is enabled from the Setup menu by means of the CURSOR key.

This window is available provided that a position is present and looks differently, depending on whether a destination has been previously set.

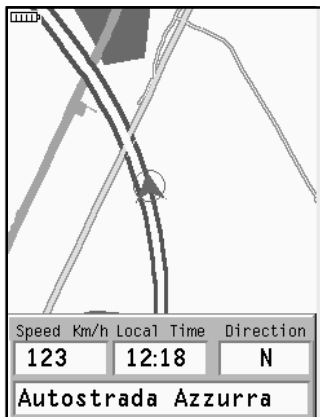

Without destination

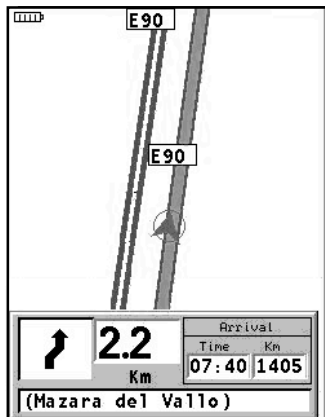

With destination

TRIP WINDOW

The trip window shows the data relating to the distance covered, time elapsed from departure, average speed and maximum speed reached from the latest reset operation or from the latest destination set.

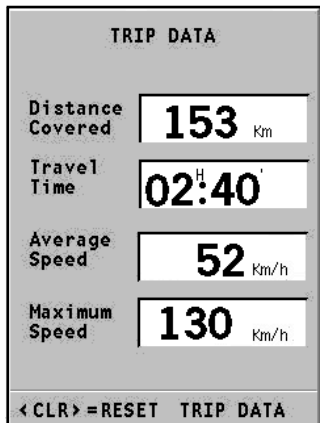

SATELLITE WINDOW

The satellite window displays the current configuration of the satellites tracked.

As soon as the unit has tracked at least three satellites, the data relative to position, current date and time are available.

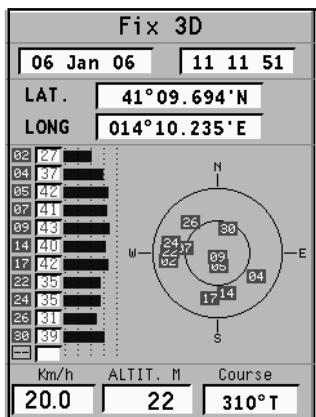

ROUTE INFO WINDOW

The route info window displays the data relative to departure and arrival, route type, distance and traveling time, as defined according to the speed set in the Setup menu.

Route Info	
From	Bellona Unnamed Road
To	Tivoli Unnamed Road
Type	Quickest
Distance	Time
180 Km	01:33 ^H '

MAIN MENU

The menu bar, displayed at the top of the screen, allows accessing the following options:

MARKER: To insert, select, define and delete markers.

ADDRESSES: To insert, select, define and delete addresses.

NEAR: To display the list of the services available, search for the nearest service, select and define the service.

SETUP: To activate/deactivate and edit the unit's operating parameters.

MARKER

Markers allow identifying points of interest and are stored in the unit's memory.

Inserting a marker

Move the cursor to the position desired, then press the ENTER key. By the CURSOR key, select MARKER from the dialog box and confirm the choice by ENTER. A window will allow defining the marker's symbol and name.

Use the CURSOR key to change the marker's symbol as well as the alphanumeric characters forming the marker's name.



The symbols available are the following:



Menu marker

Press GOTO, then select the marker desired by CURSOR. After pressing ENTER, a window will allow defining the marker as a Starting point or Destination by means of CURSOR. Confirm the operation by pressing ENTER.

If defined as Destination, the marker will be represented on the map by a symbol for finish, whereas, if defined as a Starting point, it will be represented by a flag.

NOTE: If a Starting point and Destination are present, the itinerary will be calculated and highlighted in green on the map.

Deleting a marker from the list

Press **GOTO**, then select a marker from the list by **CURSOR**.

Press **CLR** to delete the marker and confirm the operation by pressing **ENTER**.

Deleting a marker from the screen

Move the **CURSOR** key on the marker and, after displaying the page with the marker's symbol and name, press **CLR** to delete it. Confirm the deletion by **ENTER**, or cancel it by **PAGE**.



ADDRESSES

To display the list of the addresses available, press the GOTO key. A window will show the addresses already saved or will give the opportunity of entering a new address. Once confirmed, the addresses will be displayed in the list.

Entering a new address (without virtual keyboard)

To enter a new address without using the virtual keyboard, select SETUP, KEYBOARD and then disable the keyboard by selecting the OFF option.

By the CURSOR key, enable the "New" option. Always by means of CURSOR, enter only the first letter or more letters forming the name of the place desired.

A list will show the places defined by the letters entered. By using the CURSOR key, search for the place desired and confirm the selection by ENTER.



In the same way described above, in the window that follows, it will be possible to enter the name of a road and, if known, the number, or identify a point of interest by category or by name.

The CATEGORY proposes symbols and provides their meanings. The symbol selected opens the list of the places available and allows their selection. By defining a point of interest as NAME, the list of the possible choices will be shown. To confirm a selection, press ENTER.

After entering the address, define it as Destination, Marker or Starting point in the dialog box. Confirm the operation by ENTER.

NOTE: If a Starting point and Destination are present, the itinerary will be calculated and highlighted in green on the map.

Entering a new address (with virtual keyboard)

To enter a new address by means of the virtual keyboard, select **SETUP**, **KEYBOARD** and then enable the keyboard by selecting **ABC** or **QWERTY**, according to the type of keyboard desired.

By the **CURSOR** key, enable the “New” option. Always by means of **CURSOR**, select the letters on the keyboard, one by one, and confirm by **ENTER**.

A list will show the places defined by the letters entered. By using the **CURSOR** key, search for the place desired and confirm the selection by **ENTER**.

In the same way described above, in the window that follows, it will be possible to enter the name of a road and, if known, the number, or identify a point of interest by category or by name.

The **CATEGORY** proposes symbols and provides their meanings. The symbol selected opens the list of the places available and allows their selection. By defining a point of interest as



NAME, the list of the possible choices will be shown. To confirm a selection, press ENTER.

After entering the address, define it as Destination, Marker or Starting point in the dialog box. Confirm the operation by ENTER.

NOTE: If a Starting point and Destination are present, the itinerary will be calculated and highlighted in green on the map.

Selecting/defining the addresses stored

Besides what has been reported in the previous paragraph, the address menu shows the list of the addresses already entered that can be selected and defined as Destination, Marker or Starting point.

Move the cursor on the address desired and confirm the selection by pressing ENTER.

Deleting an address from the list

By the CURSOR key, select the address to delete from the list, press CLR and confirm the deletion by ENTER.



NEAR

To display the list of the services available and to search for the service nearest your position or cursor's position, select NEAR and press the GOTO key.

Selecting/defining a service

By means of the CURSOR key, scroll the list of the services available, select the service and press ENTER to confirm the operation. The display will show three icons, the largest one indicating the service nearest the reference position.

When positioning the CURSOR key on each icon, the window situated in the lower side will display the name of the service, its address and the distance from the current position. Select the icon desired and press ENTER to confirm the operation.

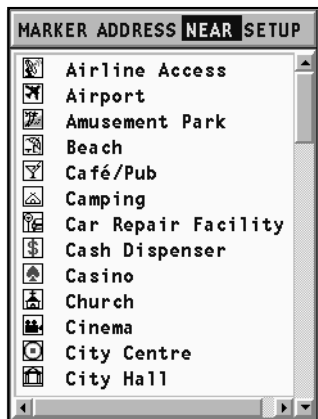

After setting the service desired, define it as Destination, Marker or Starting point in the dialog box. Confirm the operation by ENTER.

CURSOR

An itinerary can also be defined only by means of the cursor.

In the absence of a valid Fix (GPS position not detected), both the starting point and destination shall be set, as described below.

By means of the **CURSOR** key, position the cursor on a point on the screen and press **ENTER**. Define the point as a starting point in the dialog box, then confirm by **ENTER**. A flag will be displayed close to the cursor.

Position the cursor on another point and press **ENTER**. Select the **Destination** item in the dialog box and confirm by **ENTER**.

The symbol for finish will show close to the cursor. The itinerary defined between the starting point and destination will be calculated and highlighted in green on the map.

In the presence of a valid Fix (GPS position), the point selected by the cursor will be automatically considered as a destination and the itinerary traced starting from the current position.

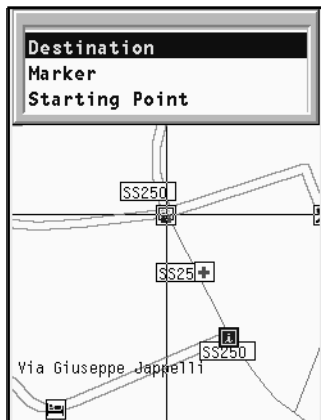

SETUP

The Setup menu allows setting the available options. To access the Setup menu, press GOTO to display the main menu, then select SETUP by using the CURSOR key.

The menu items are grouped in six sets. When selecting a set by the CURSOR key, the list of the available options will be displayed. Press ENTER to select one set, then use the CURSOR key to switch from one option to another and edit the setting. To go back to the set list, press PAGE.

MARINE NAVIGATOR

- This option allows switching from road navigation to marine navigation.

DISPLAY

- Mode (DAY/NIGHT)
Selects the colors suitable for the brightness of the environment.
- Chart Rotation (ON/OFF)
Enables/disables the Chart Rotation function.
- Presentation (EU/U.S.)
Selects the symbols and colors of chart presentation.
- Help Bars (ON/OFF)
Enables/disables the guide text to the functions.
- Keyboard (ABC/QWERTY/OFF)
Enables/disables the virtual keyboard for entering the place names.

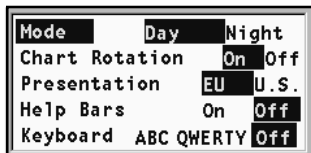

NAVIGATION

- Path (QUICKEST/SHORT-EST)
Defines the quickest or shortest way to reach the destination.



- **Roads (ALL/NO TOLL ROADS)**
Enables all the roads or excludes toll roads.
- **Usage (CAR/WALK)**
Defines the unit's use (whether on car or on foot)
- **Road Speeds**
Sets the speed limits according to the road followed.

UNITS AND LANGUAGE

- **Set Time (LOCAL/GMT)**
Enters local time.
- **Distance Units (KM/MILES)**
Selects distance units.
- **Language (EN/FR/ES/DE/DK/IT/SV/NL/SU/NO)**
Selects the language.

WINDOWS

- Enables/disables the display of the windows available.

Navigation	On	Off
Trip Window	On	Off
Satellites	On	Off
Route Info	On	Off

OTHER

- **GPS (INT/EXT)**
Selects a built-in GPS antenna or an external GPS antenna.
- **Simulation (ON/OFF)**
Enables/disables the Simulation function (available if an itinerary is present).
- **Battery Saving (ON/OFF)**
Sets the automatic switching off time for the backlight and screen, in order to reduce the battery consumption.
- **Simulation (ON/OFF)**
Enables/disables the Simulation function (available if an itinerary is present).
- **Chart Info**
Displays the title of the map currently loaded.

GPS	Int	Ext	▶
Simulation	On	Off	
Battery Saving	On	Off	
Chart Info			▶

TABLE OF CONTENTS

INTRODUCTION	3
CHARACTERISTICS	5
INSTALLATION AND PRECAUTIONS	8
CONNECTIONS	10
CARTRIDGE INSTALLATION	13
KEYBOARD	14
DIAGNOSTIC	15
MARINE NAVIGATION	17
NAVIONICS ELECTRONIC CHARTS	19
GRAPHIC ITEMS	25
FUNCTIONAL CHARACTERISTICS	27
GETTING STARTED	34
OPERATING MODES	36
RANGE WINDOW	37
NAVIGATION WINDOW	38
TRIP WINDOW	39
SATELLITE WINDOW	40
INFO WINDOW	42
TIDE INFO WINDOW	43
RUNWAY WINDOW	44
3D WINDOW	45
MAIN MENU	46
ROUTE	47

TRACK	51
MARKER	53
GOTO PORT	56
GOTO NEAREST	57
SETUP	60
GOTO LAT/LON	64
ROAD NAVIGATION	65
ROAD MAPS	67
FUNCTIONAL CHARACTERISTICS	69
GETTING STARTED	71
NAVIGATION WINDOW	72
TRIP WINDOW	73
SATELLITE WINDOW	74
ROUTE INFO WINDOW	75
MAIN MENU	76
MARKER	77
ADDRESSES	79
NEAR	82
CURSOR	83
SETUP	84